

VEST150C

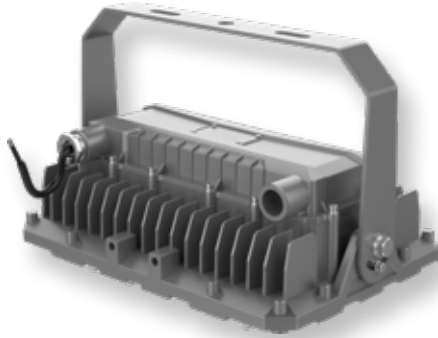

Datos Técnicos. Technical Data

Proyector ATEX VEST SMD 150W AC100-277V 3000K 19500lm 120° MW DIM Driver
Floodlight ATEX VEST SMD 150W AC100-277V 3000K 19500lm 120° MW DIM Driver

Protección. Protection (IP)	IP66 Exterior.Outdoor
Clase de Aislamiento IEC Protection Class	I
Grado de Protección IK. IK Protection Level	IK10

Información Eléctrica. Electrical Information

Vatios. Wattage	150 W
Equivalencia Vatios. Watt Equivalence	400W W
Ahorro Energético. Energy Savings	63%
Voltaje. Voltage	100-277 V
Factor Potencia. Power Factor (PF)	≥0.95
Regulable. Dimmable	Si

Información Lumínica. Light Technical Information

Flujo Luminoso. Luminous Flux (lm)	19500 Lm
Eficacia Lm. Lm Efficacy (Lm/W)	130
Temperatura Luz. Color Temperature (K)	3000K
Color Luz. Light Color	Blanco Cálido .Warm White
Color Luz. Light Color	0
Índice Reproducción Cromática (IRC). Color Rendering Index (CRI)	≥80
Ángulo Apertura. Beam Angle	120°

LED Chip

Tipo de Led. Led Type	SMD 3030
Marca chip LED. LED chip Brand	Lumileds

Información Material. Material Information

Color. Color	Plata.Silver.Silver
--------------	---------------------

Datos Medioambientales. Environmental Data

Eficiencia Energética. Energy Efficiency	A++
Consumo de Energía. Energy Consumption	150kWh/1000h

Vida Útil. Lifespan

Vida Media. Rated Lifetime	70000h
# de Encendidos. Switching Cycles	50000

Otras Especificaciones Other Specifications

Lámpara reemplazable. Replaceble lamp	0
Garantía ROBLAN. ROBLAN Warranty	5 años. years*
Marcado ATEX Europa. Europe ATEX Marking	II 2G Ex db IIC T6 Gb / II 2D Ex tb IIIC Y(80°C) Db
ATEX Zona Gas. ATEX Gas Zone	1,2
ATEX Zona Polvo. ATEX Dust Zone	21,22
ATEX,2014/34/EU	



Datos Admin & Logística. Admin Data & Logistics

Referencia Producto. Item Code	VEST150C
Modelo. Model	VEST
Gama. Range	LED PRO
Serie. Series	Proyectores LED LED Floodlights
Tecnología. Technology	LEDs LEDs
Código de Barras. Barcode	032525
Clase ETIM. ETIM Class	EC001744
Unidades/Embalaje. Units/Carton	1
Tipo Embalaje Unidad. Packaging Unit Type	Brown Carton Box
MEAS Carton	183040
Peso Bruto. Gross Weight	10.5

Avisos & Precauciones. Safety & Warnings

Rango de Temperatura (Uso) Operational Temperature Range	-40~50
Rango de Temperatura (conservación) Preservation Temperature Range	-40~80
Rango de Humedad (Uso) Operational Humidity Range	95% Rh or below(@- 40°C~-50°C)

Dimensiones e Instalación. Dimensions & Installation

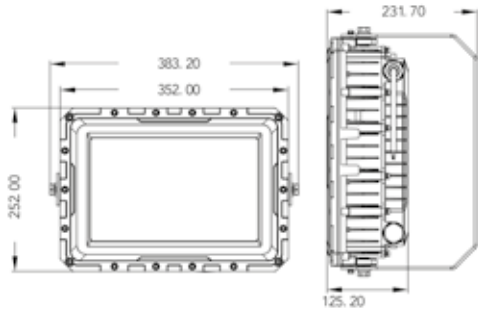

h:252
l:352
w:231

Peso producto. Product Weight	10
Instalación. Installation	Superficie. Surface
Lugar de Instalación. Installation place	Pared, Techo, Suelo. Wall, Roof, Floor

Especificaciones Ópticas. Optical Specifications

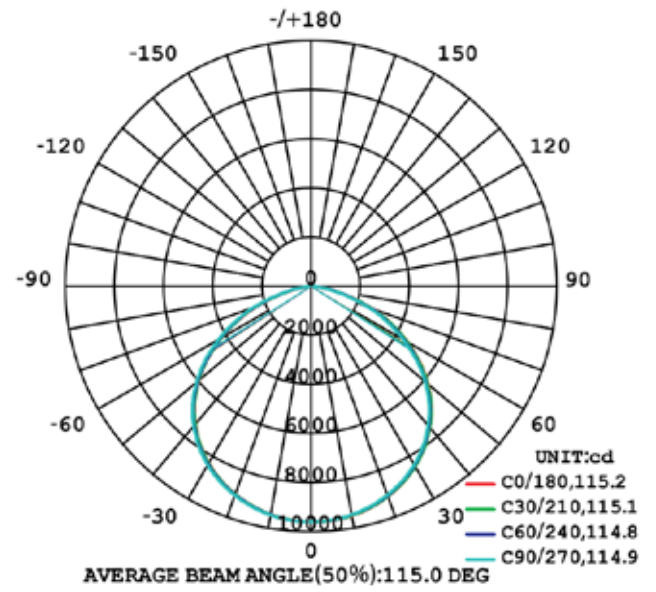

En caso de rotura. In case of breakage: www.roblan.com
 Última actualización: 2020-08-06 09:04:23 UTC+0000
 Sujeto a cambios sin previo aviso. Utilizar datos más recientes.
 Last updated: 2020-08-06 09:04:23 UTC+0000
 Subject to change without notice. Use the most recent data.